

Article number: 2029114070L1SCR

Description: E+G Linear actuators - GN 291.1-40-70-L1-SCR

Measures

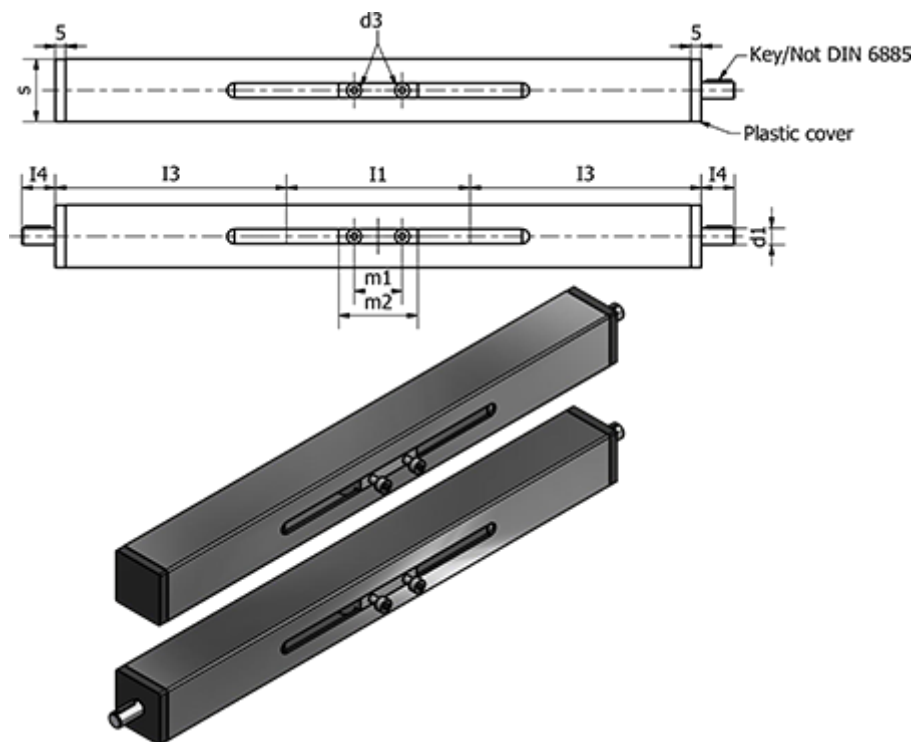

d1 f7 = 12

d2 = M5

I1 = 70

I2 = I2+240

I3 = 120

I4 = 17

m1 = 42

m2 = 54

Max. travel = 1570

s = 40

Shaft key DIN 6885 = A4x4x12

Shaft thread = TR20x4